

TVS贴片二极管

TVS SMD DIODE

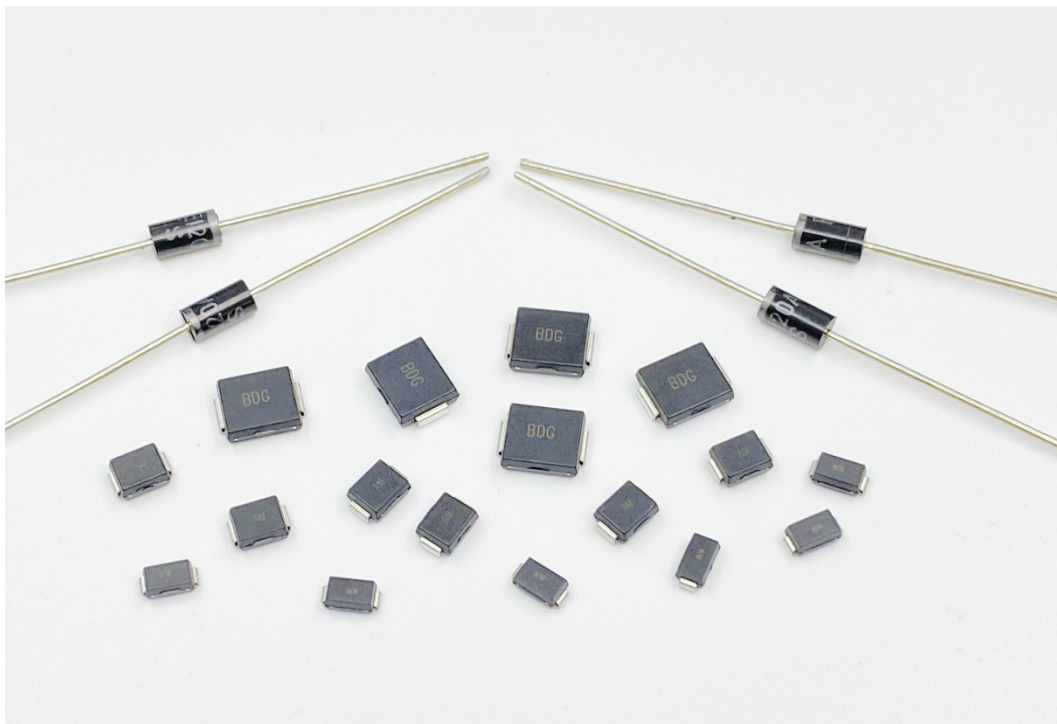

优良品质 · 诚信经营

一起携手 · 共创辉煌

SA Series

产品简介

DESCRIPTION

The SA series of high current uni/bi-directional transient suppressors are designed for A.C. line protection and high power DC bus clamping applications. These devices offer uni/bi-directional port protection from 5.0 volts to 220 volts. They provide a clamping voltage lower than the avalanche voltage. Therefore, any voltage rise due to increased current conduction is contained to a minimum, providing the best possible protection level. They can also be connected in series and/or parallel to create very high capacity protection solutions.

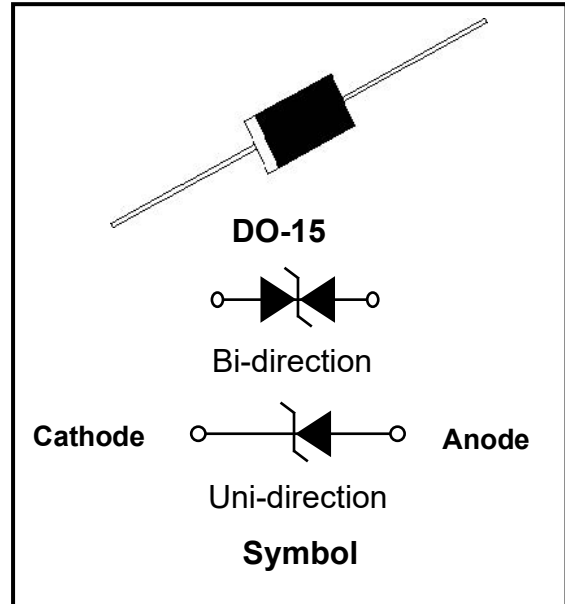

产品特征

FEATURES

- Low zener impedance.
- Excellent clamping capability.
- Repetition rate (duty cycle): 0.01%.
- JEDEC DO-15/DO-204AC Molded Plastic.
- Color band denoted cathode except bidirectional.
- High temperature soldering: 260°C/10s at terminals.
- Glass passivated chip junction in JEDEC DO-15/DO-204AC package.
- 600W Peak Pulse power capability at 10x1000 μ s waveform.
- Fast response time: typically less than 1.0ps from 0V to V_{BR} min.

绝对最大额定值
ABSOLUTE MAXIMUM RATINGS

 (T_A=25°C, RH=45%-75%, unless otherwise noted)

Parameter	Symbol	Value	Unit
Peak Pulse Power dissipation on 10/1000μs waveform	P _{PP}	500	W
Peak pulse current of on 10/1000μs waveform	I _{PP}	See next Table	A
Steady state power dissipation at T _L =75°C	P _{M(AV)}	5.0	W
Operating junction and Storage temperature range	T _{STG} , T _J	-55 to +125	°C
Peak forward surge current, 8.3ms single half sine-wave	I _{FSM}	100	A

电气特性
ELECTRICAL CHARACTERISTICS

 T_A = 25°C

Part Number		V _R	I _R @ V _R	V _{BR} @ I _T		I _T	V _C @ I _{PP}	I _{PP} ^①
Uni-Polar	Bi-Polar	V	μA	Min(V)	Max(V)	mA	Max(V)	A
SA5.0A	SA5.0CA	5.0	200	6.40	7.00	10	9.2	55.4
SA6.0A	SA6.0CA	6.0	200	6.67	7.37	10	10.3	49.5
SA6.5A	SA6.5CA	6.5	100	7.22	7.98	10	11.2	45.5
SA7.0A	SA7.0CA	7.0	50	7.78	8.60	10	12.0	42.5
SA7.5A	SA7.5CA	7.5	50	8.33	9.21	1	12.9	39.5
SA8.0A	SA8.0CA	8.0	20	8.89	9.83	1	13.6	37.5
SA8.5A	SA8.5CA	8.5	10	9.44	10.40	1	14.4	35.5
SA9.0A	SA9.0CA	9.0	5	10.00	11.10	1	15.4	33.1
SA10A	SA10CA	10.0	2	11.10	12.30	1	17.0	30.0
SA11A	SA11CA	11.0	1	12.20	13.50	1	18.2	28.0
SA12A	SA12CA	12.0	1	13.30	14.70	1	19.9	25.6
SA13A	SA13CA	13.0	1	14.40	15.90	1	21.5	23.7
SA14A	SA14CA	14.0	1	15.60	17.20	1	23.2	22.0
SA15A	SA15CA	15.0	1	16.70	18.50	1	24.4	20.9
SA16A	SA16CA	16.0	1	17.80	19.70	1	26.0	19.6
SA17A	SA17CA	17.0	1	18.90	20.90	1	27.6	18.5
SA18A	SA18CA	18.0	1	20.00	22.10	1	29.2	17.5
SA20A	SA20CA	20.0	1	22.20	24.50	1	32.4	15.7
SA22A	SA22CA	22.0	1	24.40	26.90	1	35.5	14.4
SA24A	SA24CA	24.0	1	26.70	29.50	1	38.9	13.1
SA26A	SA26CA	26.0	1	28.90	31.90	1	42.1	12.1
SA28A	SA28CA	28.0	1	31.10	34.40	1	45.4	11.2

$T_A = 25^\circ\text{C}$, continued

Part Number		V_R	$I_R @ V_R$	$V_{BR} @ I_T$		I_T	$V_C @ I_{PP}$	$I_{PP}^{\text{①}}$
Uni-Polar	Bi-Polar	V	μA	Min(V)	Max(V)	mA	Max(V)	A
SA30A	SA30CA	30.0	1	33.30	36.80	1	48.4	10.5
SA33A	SA33CA	33.0	1	36.70	40.60	1	53.3	9.6
SA36A	SA36CA	36.0	1	40.00	44.20	1	58.1	8.8
SA40A	SA40CA	40.0	1	44.40	49.10	1	64.5	7.9
SA43A	SA43CA	43.0	1	47.80	52.80	1	69.4	7.3
SA45A	SA45CA	45.0	1	50.00	55.30	1	72.7	7.0
SA48A	SA48CA	48.0	1	53.30	58.90	1	77.4	6.6
SA51A	SA51CA	51.0	1	56.70	62.70	1	82.4	6.2
SA54A	SA54CA	54.0	1	60.00	66.30	1	87.1	5.9
SA58A	SA58CA	58.0	1	64.40	71.20	1	93.6	5.4
SA60A	SA60CA	60.0	1	66.70	73.70	1	96.8	5.3
SA64A	SA64CA	64.0	1	71.10	78.60	1	103.0	5.0
SA70A	SA70CA	70.0	1	77.80	86.00	1	113.0	4.5
SA75A	SA75CA	75.0	1	83.30	92.10	1	121.0	4.2
SA78A	SA78CA	78.0	1	86.70	95.80	1	126.0	4.0
SA85A	SA85CA	85.0	1	94.40	104.0	1	137.0	3.7
SA90A	SA90CA	90.0	1	100.0	111.0	1	146.0	3.5
SA100A	SA100CA	100.0	1	100.0	111.0	1	162.0	3.1
SA110A	SA110CA	110.0	1	111.0	123.0	1	177.0	2.9
SA120A	SA120CA	120.0	1	122.0	135.0	1	193.0	2.6
SA130A	SA130CA	130.0	1	133.0	147.0	1	209.0	2.4
SA150A	SA150CA	150.0	1	144.0	159.0	1	243.0	2.1
SA160A	SA160CA	160.0	1	167.0	185.0	1	259.0	2.0
SA170A	SA170CA	170.0	1	178.0	197.0	1	275.0	1.9
SA180A	SA180CA	180.0	1	189.0	209.0	1	292.0	1.7
SA200A	SA200CA	200.0	1	201.0	222.0	1	324.0	1.5
SA220A	SA220CA	220.0	1	211.0	234.0	1	356.0	1.4

① Surge waveform: 10/1000 μs

V_R : Stand-off Voltage -- Maximum voltage that can be applied

V_{BR} : Breakdown Voltage

V_C : Clamping Voltage -- Peak voltage measured across the suppressor at a specified I_{PP}

I_R : Reverse Leakage Current

额定值和 V-I 特性曲线

RATINGS AND V-I CHARACTERISTICS CURVES

$T_A=25^{\circ}\text{C}$, unless otherwise noted

Fig.1: V-I curve characteristics (Uni-directional)

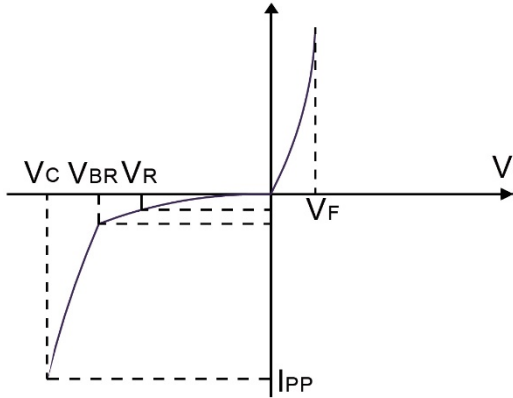

Fig.2: V-I curve characteristics (Bi-directional)

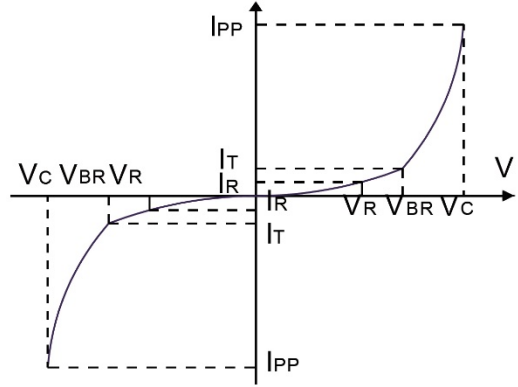

Fig.3: Pulse waveform

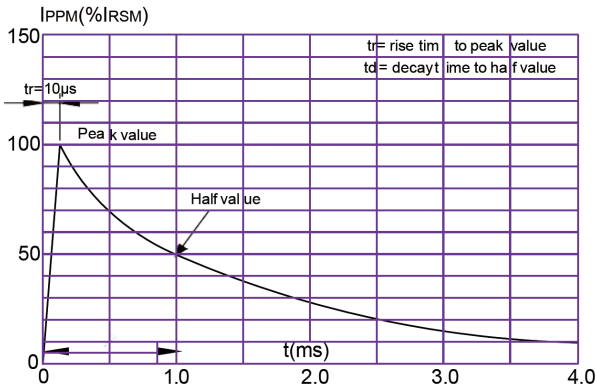
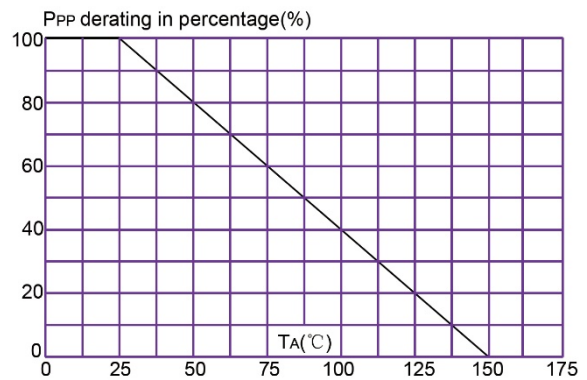

Fig. 4 Pulse derating curve



焊接参数

SOLDERING PARAMETERS

Reflow Condition		Pb-Free assembly (see FIG.5)
Pre Heat	-Temperature Min ($T_{s(min)}$)	+150°C
	-Temperature Max($T_{s(max)}$)	+200°C
	-Time (Min to Max) (t_s)	60-180 secs.
Average ramp up rate (Liquid us Temp (T_L) to peak)		3°C/sec. Max
$T_{s(max)}$ to T_L - Ramp-up Rate		3°C/sec. Max
Reflow	-Temperature(T_L)(Liquid us)	+217°C
	-Temperature(t_L)	60-150 secs.
Peak Temp (T_p)		+260(+0/-5)°C
Time within 5°C of actual Peak Temp (t_p)		30 secs. Max
Ramp-down Rate		6 °C/sec. Max
Time 25°C to Peak Temp (T_p)		8min. Max
Do not exceed		+260°C

Fig. 5 Reflow condition

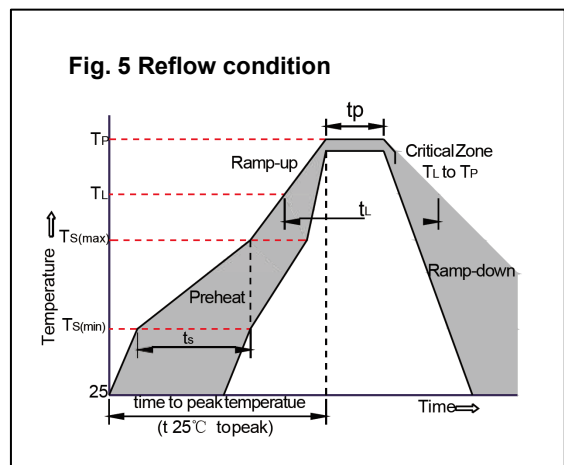

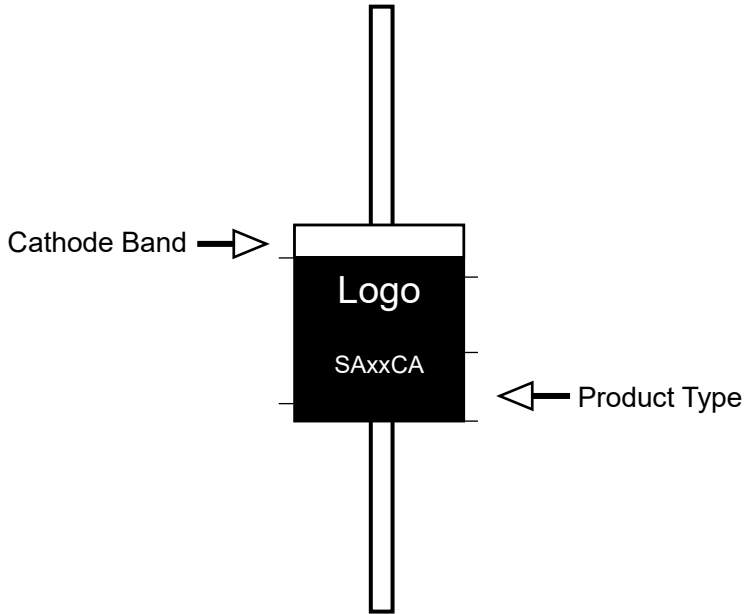
标记和订购信息
MARKING & ORDERING INFORMATION

SA	XX	C	A
(1)	(2)	(3)	(4)

- (1) Series:500 watts series
- (2) Reverse Stand-off Voltage
- (3) Bi-directional
- (4) 5% V_{BR} Voltage tolerance

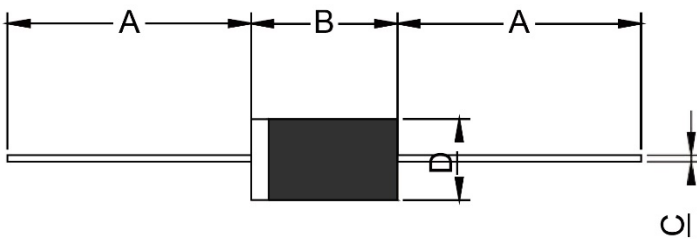
机械数据
PACKAGE MECHANICAL DATA

Ref.	Dimensions			
	Inches		Millimeters	
	Min.	Max.	Min.	Max.
A	1.000	-	25.40	-
B	0.228	0.300	5.80	7.62
C	0.027	0.035	0.69	0.89
D	0.118	0.140	3.00	3.60

Part Number	Case Type	Quantity	Packing Option
SAXXCA/A	DO-15/DO-204AC	2000	Box