

TVS贴片二极管

TVS SMD DIODE

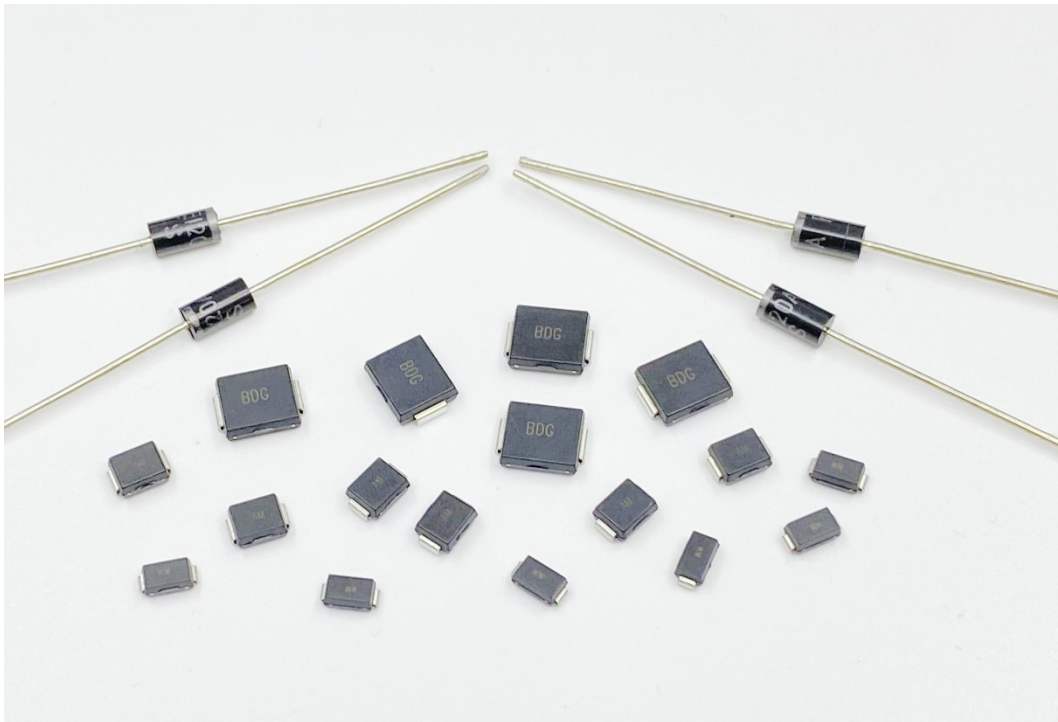

优良品质 · 诚信经营

一起携手 · 共创辉煌

1.5KE Series

产品简介

DESCRIPTION

The 1.5KE series of high current uni/bi-directional transient suppressors are designed for A.C. line protection and high power DC bus clamping applications. These devices offer uni/bi-directional port protection from 6.8 volts to 440 volts. They provide a clamping voltage lower than the avalanche voltage. Therefore, any voltage rise due to increased current conduction is contained to a minimum, providing the best possible protection level. They can also be connected in series and/or parallel to create very high capacity protection solutions.

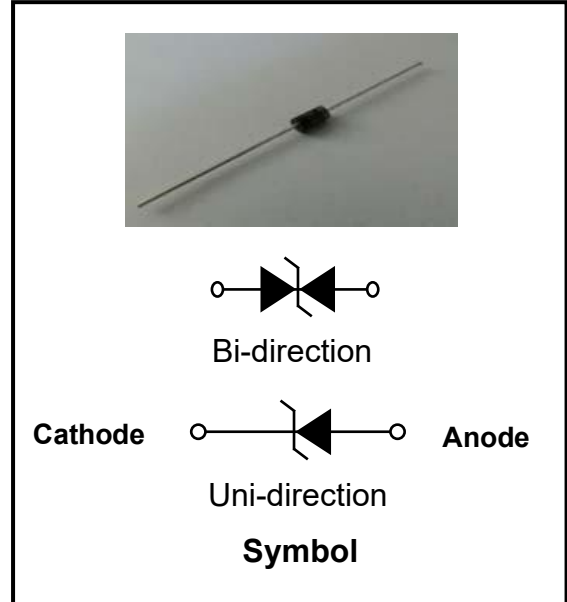

产品特征

FEATURES

- Low zener impedance.
- Excellent clamping capability.
- Repetition rate (duty cycle): 0.01%.
- JEDEC DO-27/DO-201 Molded Plastic.
- Color band denoted cathode except bidirectional.
- High temperature soldering: 260°C/10s at terminals.
- Glass passivated chip junction in DO-27/DO-201 package.
- 1500W Peak Pulse power capability at 10x1000μs waveform.
- Fast response time: typically less than 1.0ps from 0V to V_{BR} min.

绝对最大额定值
ABSOLUTE MAXIMUM RATINGS

 (T_A=25°C, RH=45%-75%, unless otherwise noted)

Parameter	Symbol	Value	Unit
Peak Pulse Power dissipation on 10/1000μs waveform	P _{PP}	1500	W
Peak pulse current of on 10/1000μs waveform	I _{PP}	See next Table	A
Steady state power dissipation at T _L =75°C	P _{M(AV)}	6.5	W
Operating junction and Storage temperature range	T _{STG} , T _J	-55 to +150	°C
Peak forward surge current, 8.3ms single half sine-wave	I _{FSM}	200	A

电气特性
ELECTRICAL CHARACTERISTICS

 T_A = 25°C

Part Number		V _R	I _R @ V _R	V _{BR} @ I _T		I _T	V _C @ I _{PP}	I _{PP} ^①
Uni-Polar	Bi-Polar	V	μA	Min(V)	Max(V)	mA	Max(V)	A
1.5KE6.8A	1.5KE6.8CA	5.8	150	6.45	7.14	10	10.5	147.1
1.5KE7.5A	1.5KE7.5CA	6.4	100	7.13	7.88	10	11.3	132.8
1.5KE8.2A	1.5KE8.2CA	7.02	50	7.79	8.61	10	12.1	124.0
1.5KE9.1A	1.5KE9.1CA	7.78	20	8.65	9.55	1	13.4	112.0
1.5KE10A	1.5KE10CA	8.55	10	9.50	10.50	1	14.5	103.5
1.5KE11A	1.5KE11CA	9.4	5	10.50	11.60	1	15.6	96.2
1.5KE12A	1.5KE12CA	10.2	2	11.40	12.60	1	16.7	89.8
1.5KE13A	1.5KE13CA	11.1	1	12.40	13.70	1	18.2	82.5
1.5KE15A	1.5KE15CA	12.8	1	14.30	15.80	1	21.2	70.8
1.5KE16A	1.5KE16CA	13.6	1	15.20	16.80	1	22.5	66.7
1.5KE18A	1.5KE18CA	15.3	1	17.10	18.90	1	25.2	59.6
1.5KE20A	1.5KE20CA	17.1	1	19.00	21.00	1	27.7	54.2
1.5KE22A	1.5KE22CA	18.8	1	20.90	23.10	1	30.6	49.1
1.5KE24A	1.5KE24CA	20.5	1	22.80	25.20	1	33.2	45.2
1.5KE27A	1.5KE27CA	23.1	1	25.70	28.40	1	37.5	40.0
1.5KE30A	1.5KE30CA	25.6	1	28.50	31.50	1	41.4	36.3
1.5KE33A	1.5KE33CA	28.2	1	31.40	34.70	1	45.7	32.9
1.5KE36A	1.5KE36CA	30.8	1	34.20	37.80	1	49.9	30.1
1.5KE39A	1.5KE39CA	33.3	1	37.10	41.00	1	53.9	27.9
1.5KE43A	1.5KE43CA	36.8	1	40.90	45.20	1	59.3	25.3
1.5KE47A	1.5KE47CA	40.2	1	44.70	49.40	1	64.8	23.2
1.5KE51A	1.5KE51CA	43.6	1	48.50	53.60	1	70.1	21.4

$T_A = 25^\circ\text{C}$, continued

Part Number		V_R	$I_R @ V_R$	$V_{BR} @ I_T$		I_T	$V_C @ I_{PP}$	$I_{PP}^{\text{①}}$
Uni-Polar	Bi-Polar	V	μA	Min(V)	Max(V)	mA	Max(V)	A
1.5KE56A	1.5KE56CA	47.8	1	53.20	58.80	1	77.0	19.5
1.5KE62A	1.5KE62CA	53.0	1	58.90	65.10	1	85.0	17.7
1.5KE68A	1.5KE68CA	58.1	1	64.60	71.40	1	92.0	16.4
1.5KE75A	1.5KE75CA	64.1	1	71.30	78.80	1	103.0	14.6
1.5KE82A	1.5KE82CA	70.1	1	77.90	86.10	1	113.0	13.3
1.5KE91A	1.5KE91CA	77.8	1	86.50	95.50	1	125.0	12.0
1.5KE100A	1.5KE100CA	85.5	1	95.00	105.0	1	137.0	11.0
1.5KE110A	1.5KE110CA	94.0	1	105.0	116.0	1	152.0	10.0
1.5KE120A	1.5KE120CA	102.0	1	114.0	126.0	1	165.0	9.1
1.5KE130A	1.5KE130CA	111.0	1	124.0	137.0	1	179.0	8.4
1.5KE150A	1.5KE150CA	128.0	1	143.0	158.0	1	207.0	7.3
1.5KE160A	1.5KE160CA	136.0	1	152.0	168.0	1	219.0	6.9
1.5KE170A	1.5KE170CA	145.0	1	162.0	179.0	1	234.0	6.5
1.5KE180A	1.5KE180CA	154.0	1	171.0	189.0	1	246.0	6.1
1.5KE200A	1.5KE200CA	171.0	1	190.0	210.0	1	274.0	5.5
1.5KE220A	1.5KE220CA	185.0	1	209.0	231.0	1	328.0	4.6
1.5KE250A	1.5KE250CA	214.0	1	237.0	263.0	1	344.0	4.4
1.5KE300A	1.5KE300CA	256.0	1	285.0	315.0	1	414.0	3.7
1.5KE350A	1.5KE350CA	300.0	1	332.0	368.0	1	482.0	3.2
1.5KE400A	1.5KE400CA	342.0	1	380.0	420.0	1	548.0	2.8
1.5KE440A	1.5KE440CA	376.0	1	418.0	462.0	1	602.0	2.5

① Surge waveform: 10/1000 μs

V_R : Stand-off Voltage -- Maximum voltage that can be applied

V_{BR} : Breakdown Voltage

V_C : Clamping Voltage -- Peak voltage measured across the suppressor at a specified I_{PP}

I_R : Reverse Leakage Current

额定值和 V-I 特性曲线

RATINGS AND V-I CHARACTERISTICS CURVES

$T_A=25^{\circ}\text{C}$, unless otherwise noted

Fig.1: V-I curve characteristics (Uni-directional)

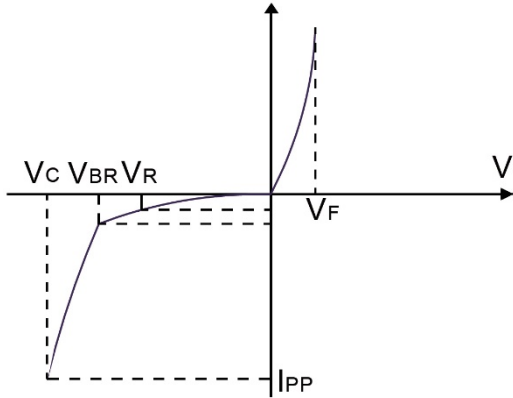

Fig.2: V-I curve characteristics (Bi-directional)

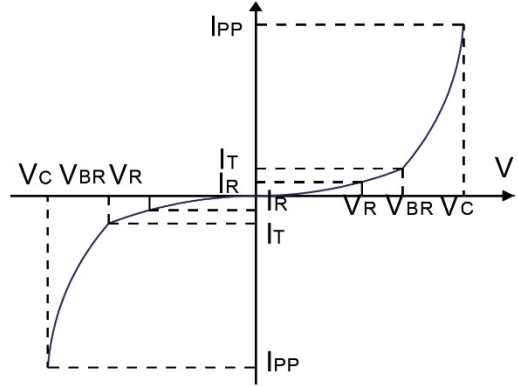

Fig.3: Pulse waveform

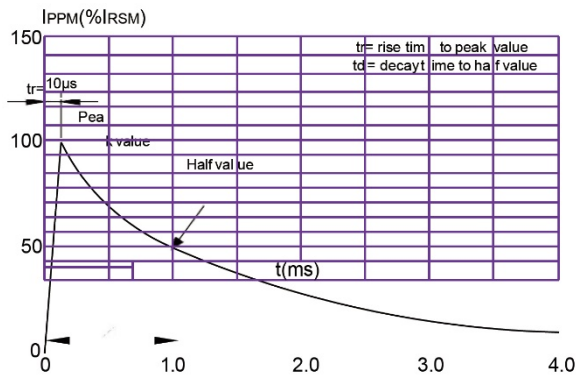
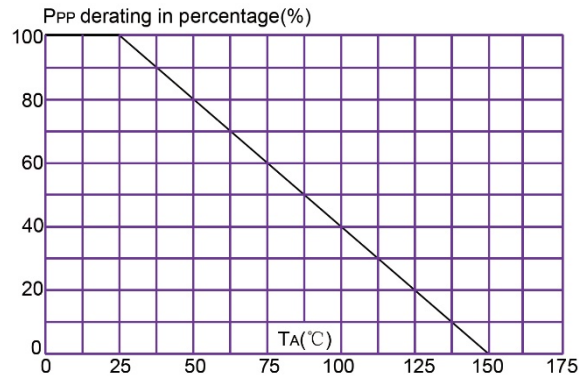

Fig. 4 Pulse derating curve



焊接参数

SOLDERING PARAMETERS

Reflow Condition		Pb-Free assembly (see FIG.5)
Pre Heat	-Temperature Min ($T_{s(min)}$)	+150°C
	-Temperature Max($T_{s(max)}$)	+200°C
	-Time (Min to Max) (t_s)	60-180 secs.
Average ramp up rate (Liquid us Temp (T_L) to peak)		3°C/sec. Max
$T_{s(max)}$ to T_L - Ramp-up Rate		3°C/sec. Max
Reflow	-Temperature(T_L)(Liquid us)	+217°C
	-Temperature(T_L)	60-150 secs.
Peak Temp (T_p)		+260(+0/-5)°C
Time within 5°C of actual Peak Temp (t_p)		30 secs. Max
Ramp-down Rate		6°C/sec. Max
Time 25°C to Peak Temp (T_p)		8min. Max
Do not exceed		+260°C

Fig. 5 Reflow condition

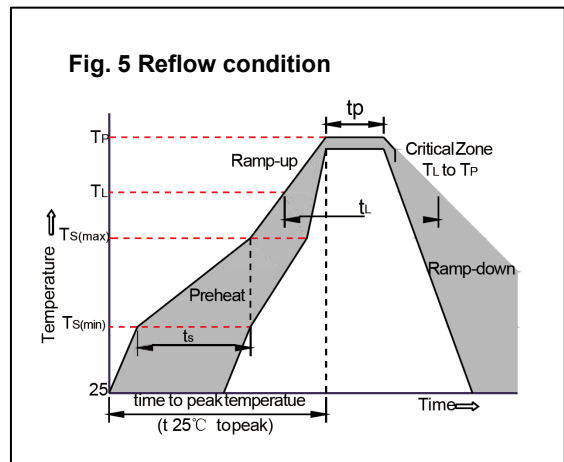

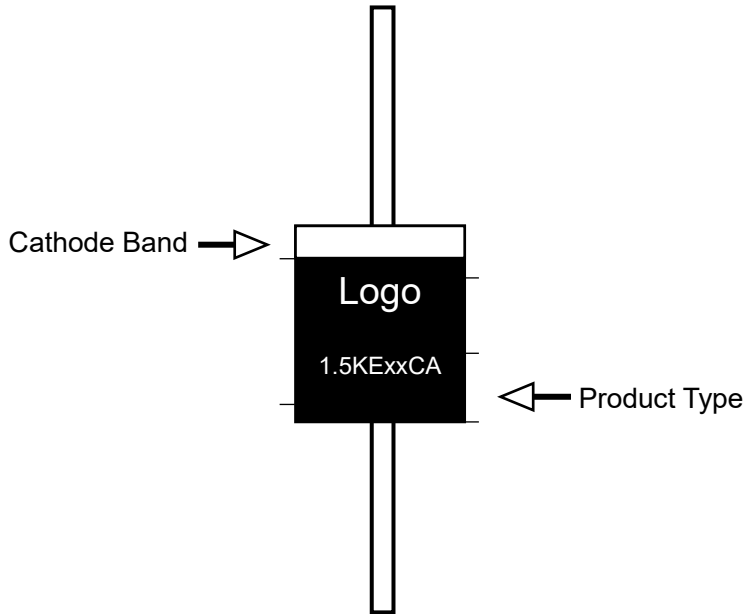
标记和订购信息
MARKING & ORDERING INFORMATION

- | | | | |
|-------|-----|-----|-----|
| 1.5KE | XX | C | A |
| (1) | (2) | (3) | (4) |
- (1) Series: 1500 watts series
 (2) Reverse Stand-off Voltage
 (3) Bi-directional
 (4) 5% V_{BR} Voltage tolerance

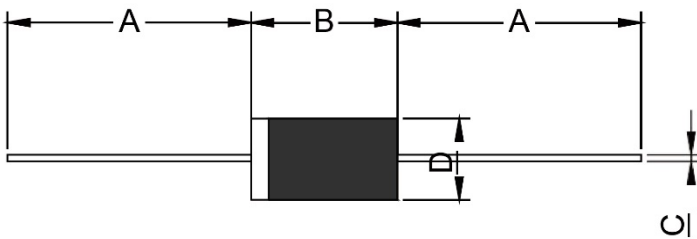
机械数据
PACKAGE MECHANICAL DATA

Ref.	Dimensions			
	Inches		Millimeters	
	Min.	Max.	Min.	Max.
A	1.000	-	25.40	-
B	0.339	0.362	8.60	9.20
C	0.045	0.057	1.15	1.45
D	0.193	0.221	4.90	5.60

Part Number	Case Type	Quantity	Packing Option
1.5KEXXCA/A	DO-27/DO-201	1000	Box